

upper collection

l'aspetto sinuoso
della funzione



PLUS:
sistema con schiene relax e
variazione profondità della seduta
system with relax backs and
adjustable seat depth



Tre diverse interpretazioni

Three different interpretations

upper
twist



pag. 04
pag. 18
pag. 30
pag. 40 informazioni
tecniche

upper
top



pag. 10
pag. 22
pag. 34
pag. 39 informazioni
tecniche

Sistema con
schiene relax.

Da scoprire.
Da provare.

Un unico modello, tre declinazioni possibili. Il design del bracciolo e il sistema di schiene relax dettano la dimensione del comfort.

System with relax backs. One model, three possible solutions.
To discover. The design of the armrest and the system with relax backs determine the level of comfort.
To try.

upper
tidy



pag. 08
pag. 14
pag. 24
pag. 28
pag. 38 informazioni
tecniche

upper
twist



upper - twist

Divano cm 230.
Piede Fine finitura manganese.
Due cuscini cm 40x40.

230 cm sofa.
Fine feet in manganese finish.
Two 40x40 cm cushions.

upper
twist

Colori e forme
da scegliere
in libertà

*Colours and shapes to select
in full freedom*



Oasi di
assoluto relax

Oasis of absolute relaxation



Il divano Upper Twist diventa espressione di comodità e creatività grazie alla possibilità di personalizzazione dei cuscini.

The Upper Twist sofa becomes an expression of comfort and creativity, thanks to the ability to customise the cushions.

upper
tidy



upper - tidy

Divano laterale cm 195 sx e
panchetta maxi dx.

1195 cm left sided sofa and
right sided maxi bench.

upper
top



upper - top

Divano laterale cm 155 dx e
divano laterale cm 155 sx.
Due cuscini cm 40x40.
Un telo arredo.

155 cm right sided sofa
and 155 cm left sided sofa.
Two 40x40 cm cushions.
One decorative throw.

upper
top



La curva diventa avvolgente

*The curve takes on an
enveloping personality*



Il bracciolo sagomato
e il movimento
delle schiene
assecondano ogni
esigenza di comfort
diventando elementi
imprescindibili
di un'estetica
funzionale.

*The shaped armrest
and the movement
of the backs indulge
every need for
comfort, becoming
indispensable elements
of a functional style.*



upper
tidy



upper - tidy

Divano cm 220.
Piede Model finitura manganese.
Un cuscino cm 40x40.
Due cover.

220 cm sofa.
Model feet in manganese finish.
One 40x40 cm cushion.
Two covers.

upper
tidy



Praticità e stile quotidiani

Daily practicality and style



Dinamismo estetico
incredibilmente
affascinante. Forme
in perfetto equilibrio
si combinano per
creare atmosfere
uniche e rilassanti.

*Incredibly charming
aesthetic dynamism.
Perfectly balanced
shapes combine to
create unique and
relaxing atmospheres.*

upper
twist



upper - twist

Divano laterale c/pouff dx.
Piede Frame finitura grigio.
Un cuscino cm 40x40.

Right sided sofa with pouf.
Frame feet in grey finish.
One 40x40 cm cushion.

upper
twist

Personali
percorsi
di stile

Personal journeys of style



Si tratta solo
di scegliere

It is all about choice



upper - twist

Divano laterale c/pouff dx con
cuscini schienale.
Piede Frame finitura grigio.

Right sided sofa with pouf and
back cushions.

Frame feet in grey finish.

Storie che raccontano
idee e visioni di
benessere e relax.

A soluzioni che
vivono di un design
esclusivo e minimale
si affiancano risposte
dall'accezione più
tradizionale.

Alla schiena relax
si possono infatti
associare o i cuscini
arredo o i tradizionali
cuscini schienale.

*Stories that narrate
ideas and visions
of well-being and
relaxation.*

*Solutions inspired
by an exclusive and
minimal design, come
together with more
traditional formulas.*

*The relax back can in
fact be complemented
with decor cushions or
with traditional back
cushions.*

upper
top



upper - top

Componibile panchetta sx.
Piede Model finitura cromo.
Un cuscino cm 40x40.
Plaid.

Left sided modular bench.
Model feet in chrome finish.
One 40x40 cm cushion.
Throw.

upper
tidy



upper - tidy

Divano laterale cm 195 sx e
penisola angolare con Even
colore beige cm 225 dx.
Piede Nice finitura manganese.
Due cuscini cm 40x40.

195 cm left sided sofa
and 225 cm right sided corner chaise
with Even accessory in beige.
Nice feet in manganese finish.
Two 40x40 cm cushions.

upper
tidy



L'accessorio diventa funzionale

*The accessory becomes
functional*



L'ampia gamma di accessori disponibile eleva la concezione classica di divano, offrendo soluzioni che lo trasformano in un vero e proprio spazio da vivere.

The wide range of accessories available elevates the classic concept of the sofa, offering solutions that transform it into a true living space.

upper
tidy



upper - tidy

Divano cm 240.
Piede Frame finitura manganese.

240 cm sofa.
Frame feet in manganese finish.

upper
twist



upper - twist

Divano laterale cm 200 sx e
panchetta maxi dx.
Piede Fine finitura manganese.
Un cuscino cm 40x40.

200 cm left sided sofa and
right sided maxi bench.
Fine feet in manganese finish.
One 40x40 cm cushion.

upper
twist

Ispirazione ed eleganza

Inspiration and elegance



Impatto e creatività.
Upper twist si
racconta attraverso
la sua versatilità
estetica: diverse
combinazioni
definiscono una
sorta di non-stop al
desiderio di comfort.

*Impact and creativity.
The upper twist model
is characterised by its
aesthetic versatility:
different combinations
define a sort of non-
stop desire for comfort.*



upper
top



upper - top

Divano laterale cm 195 dx e
penisola angolare con pouff e
tre cuscini cm 235 sx.
Piede Model finitura cromo.
Due cuscini cm 40x40.
Una cover.

195 cm left sided sofa and 235 cm right
sided corner chaise with
pouff and three cushions.
Model feet in chrome finish.
Two 40x40 cm cushions.
One cover.

upper
collection

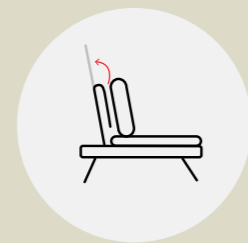

PLUS:
sistema con schiene relax e
variazione profondità della seduta
system with relax backs and
adjustable seat depth

Informazioni Tecniche

Technical Sheet

upper tidy

divani/elementi

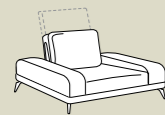

Poltrona
L 115 P 98 H 75/98

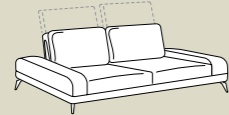

Divano
L 180 P 98 H 75/98

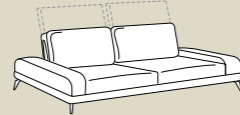

Divano
L 200 P 98 H 75/98

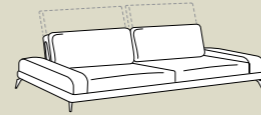

Divano
L 220 P 98 H 75/98

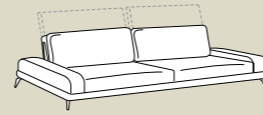

Divano
L 240 P 98 H 75/98

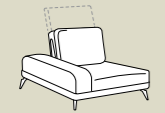

Poltrona
laterale dx/sx
L 100 P 98 H 75/98

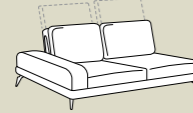

Divano
laterale dx/sx
L 155 P 98 H 75/98

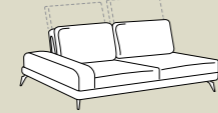

Divano
laterale dx/sx
L 175 P 98 H 75/98

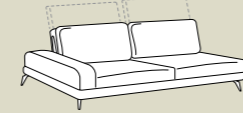

Divano
laterale dx/sx
L 195 P 98 H 75/98

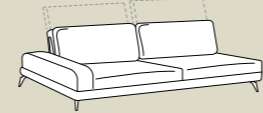

Divano
laterale dx/sx
L 215 P 98 H 75/98

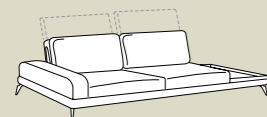

Divano laterale
c/Even dx/sx
L 220 P 98 H 75/98

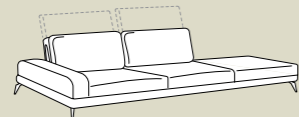

Divano laterale
c/pouff dx/sx
L 230 P 98 H 75/98

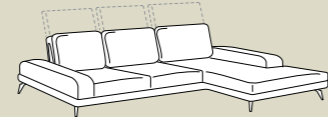

Componibile
c/panchetta dx/sx
L 245 P 154 H 75/98

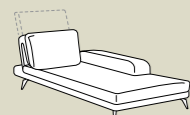

Panchetta dx/sx
L 100 P 154 H 75/98

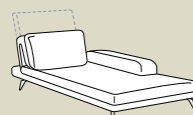

Panchetta Maxi dx/sx
L 110 P 154 H 75/98

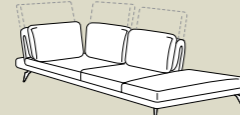

Penisola angolare
c/pouff dx/sx
L 98 P 225 H 75/98

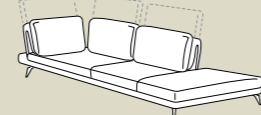

Penisola angolare
c/pouff dx/sx
L 98 P 235 H 75/98



Penisola angolare c/pouff
e 3 cuscini dx/sx
L 98 P 225 H 75/98

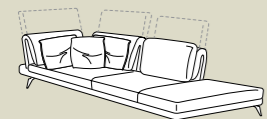

Penisola angolare c/pouff
e 3 cuscini dx/sx
L 98 P 235 H 75/98

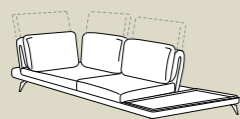

Penisola angolare
c/Even dx/sx
L 98 P 215 H 75/98

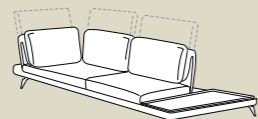

Penisola angolare
c/Even dx/sx
L 98 P 225 H 75/98

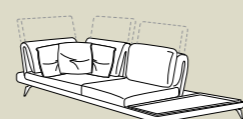

Penisola angolare c/Even
e 3 cuscini dx/sx
L 98 P 215 H 75/98



Penisola angolare c/Even
e 3 cuscini dx/sx
L 98 P 225 H 75/98

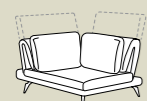

Angolo retto
L 98 P 98 H 75/98



Angolo retto
e 3 cuscini
L 98 P 98 H 75/98



Pouff
L 80 P 60 H 39

upper top

divani/elementi

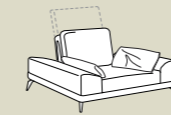

Poltrona
L 115 P 98 H 75/98

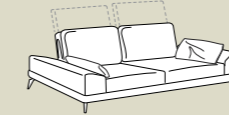

Divano
L 180 P 98 H 75/98

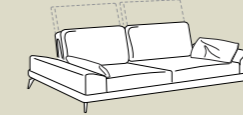

Divano
L 200 P 98 H 75/98

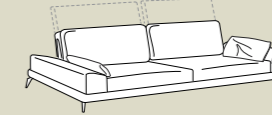

Divano
L 220 P 98 H 75/98

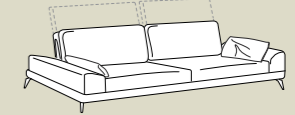

Divano
L 240 P 98 H 75/98



Poltrona
laterale dx/sx
L 100 P 98 H 75/98

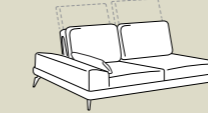

Divano
laterale dx/sx
L 155 P 98 H 75/98

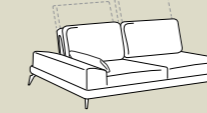

Divano
laterale dx/sx
L 175 P 98 H 75/98

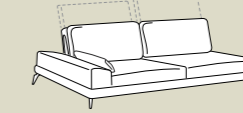

Divano
laterale dx/sx
L 195 P 98 H 75/98

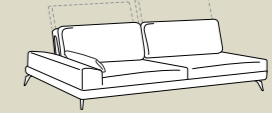

Divano
laterale dx/sx
L 215 P 98 H 75/98

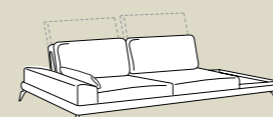

Divano laterale
c/Even dx/sx
L 220 P 98 H 75/98

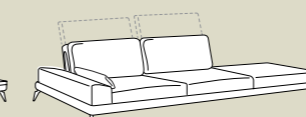

Divano laterale
c/pouff dx/sx
L 230 P 98 H 75/98

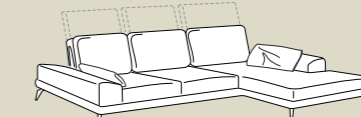

Componibile
c/panchetta dx/sx
L 245 P 154 H 75/98



Panchetta dx/sx
L 100 P 154 H 75/98

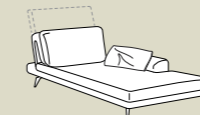

Panchetta Maxi dx/sx
L 110 P 154 H 75/98

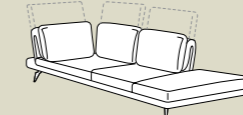

Penisola angolare
c/pouff dx/sx
L 98 P 225 H 75/98

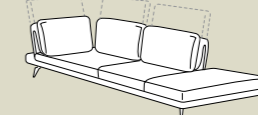

Penisola angolare
c/pouff dx/sx
L 98 P 235 H 75/98

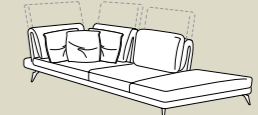

Penisola angolare c/pouff
e 3 cuscini dx/sx
L 98 P 225 H 75/98

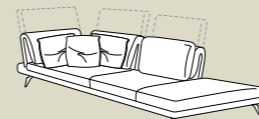

Penisola angolare c/pouff
e 3 cuscini dx/sx
L 98 P 235 H 75/98

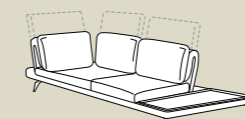

Penisola angolare
c/Even dx/sx
L 98 P 215 H 75/98

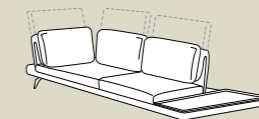

Penisola angolare
c/Even dx/sx
L 98 P 225 H 75/98



Penisola angolare c/Even
e 3 cuscini dx/sx
L 98 P 215 H 75/98

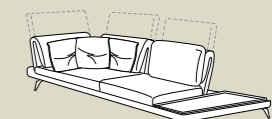

Penisola angolare c/Even
e 3 cuscini dx/sx
L 98 P 225 H 75/98

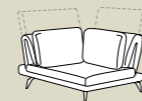

Angolo retto
L 98 P 98 H 75/98



Angolo retto
e 3 cuscini
L 98 P 98 H 75/98



Pouff
L 80 P 60 H 39

upper twist

divani/elementi

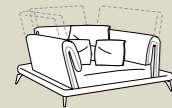

Poltrona
L 125 P 98 H 75/98



Divano
L 190 P 98 H 75/98

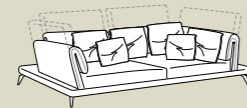

Divano
L 210 P 98 H 75/98

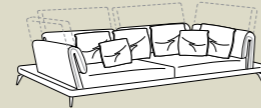

Divano
L 230 P 98 H 75/98

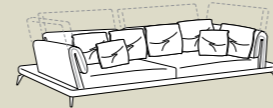

Divano
L 250 P 98 H 75/98

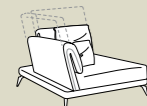

Poltrona
laterale dx/sx
L 105 P 98 H 75/98

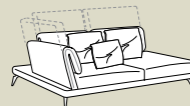

Divano
laterale dx/sx
L 160 P 98 H 75/98

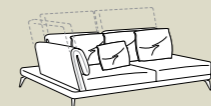

Divano
laterale dx/sx
L 180 P 98 H 75/98

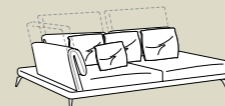

Divano
laterale dx/sx
L 200 P 98 H 75/98

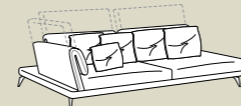

Divano
laterale dx/sx
L 220 P 98 H 75/98

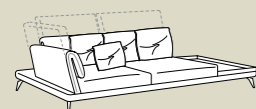

Divano laterale
c/Even dx/sx
L 225 P 98 H 75/98

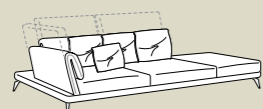

Divano laterale
c/pouff dx/sx
L 235 P 98 H 75/98



Panchetta dx/sx
L 105 P 154 H 75/98

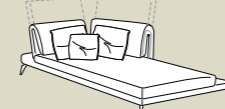

Panchetta Maxi dx/sx
L 115 P 154 H 75/98

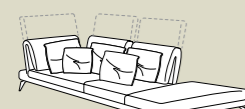

Penisola angolare
c/pouff dx/sx
L 98 P 225 H 75/98



Penisola angolare
c/pouff dx/sx
L 98 P 235 H 75/98

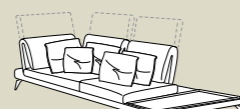

Penisola angolare
c/Even dx/sx
L 98 P 215 H 75/98

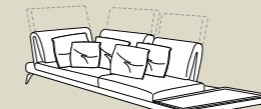

Penisola angolare
c/Even dx/sx
L 98 P 225 H 75/98



Angolo retto
L 98 P 98 H 75/98



Pouff
L 80 P 60 H 39

upper tidy/top/twist

accessori



Cuscino
L 40 x 40



Cuscino
L 50 x 50



Cuscino
L 55 x 30

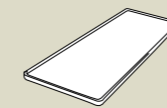

Accessorio Even
43 x 93



Finitura nera
di serie.
*Standard black
finishes.*

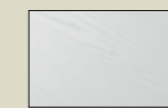

Finitura bianca
optional.
*Optional white
finishes.*

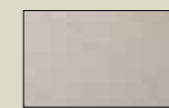

Finitura beige
optional.
*Optional beige
finishes.*



Cover per schiene
relax



Piede Nice finitura
cromo di serie, finitura
manganese optional.

*Nice feet in chrome finish
as standard, manganese
finish optional.*

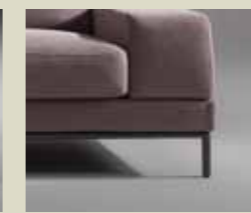

Piede Frame finitura
grigio o manganese
optional.

*Frame feet in grey finish
or in optional manganese
finish.*



Piede Fine finitura
cromo o manganese
optional.

*Fine feet in chrome finish
or in optional manganese
finish.*



Piede Model finitura
cromo o manganese
optional.

*Model feet in chrome
finish or in optional
manganese finish.*

In UPPER TWIST i cuscini schienale cm 40x40 e cm 50x50 previsti di serie, si possono sostituire a richiesta con i cuscini schienale "tradizionali" come nelle versioni Tidy e Top.

In the UPPER TWIST model, the standard 40 cm x 40 cm and 50 cm x 50 cm back cushions can be replaced, on request, with "traditional" cushions such as those offered with the Tidy and Top models.

upper tidy/top/twist

informazioni tecniche

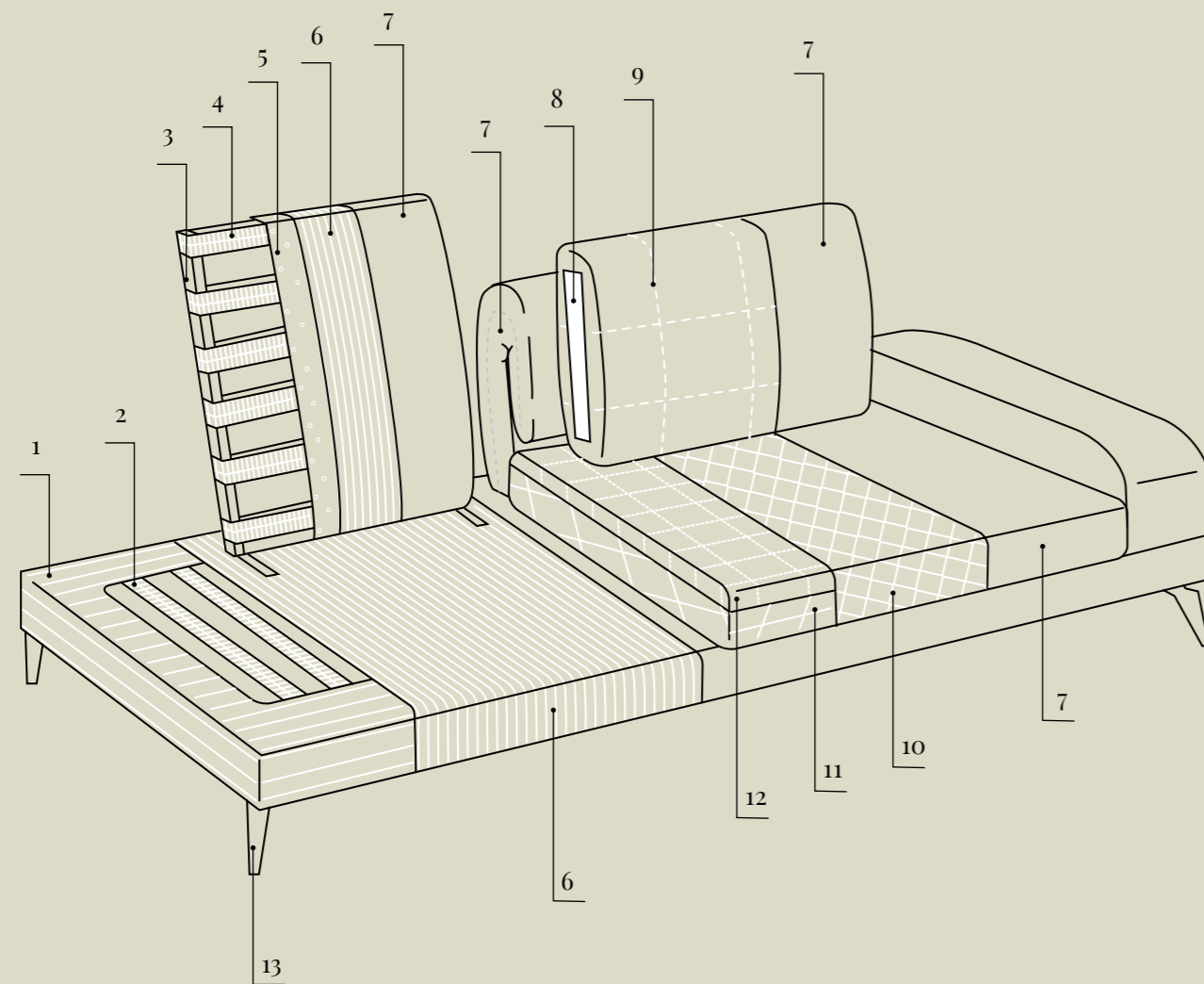

Upper
Tidy

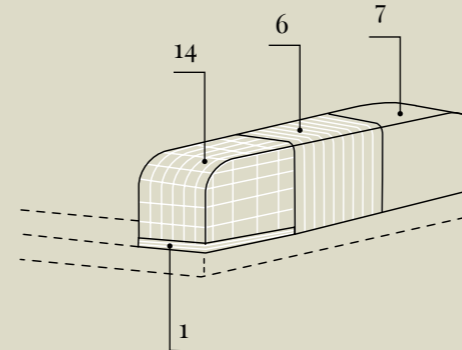

Upper
Top

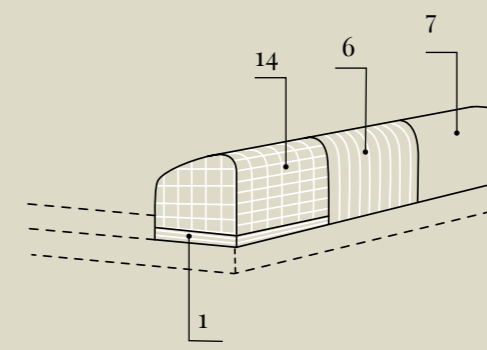

Upper
Twist

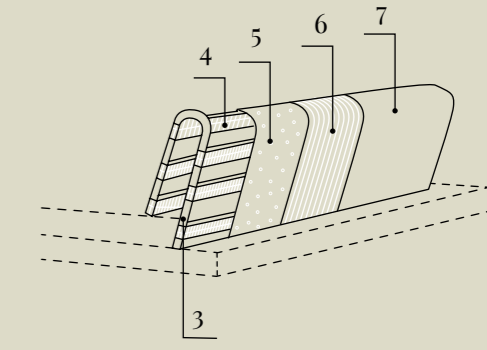

Legenda

1. Struttura in legno stagionato e agglomerato.
Structure in seasoned and bonded wood.
2. Molleggio seduta nastri elastici in fibra propilenica e lattice da 80 mm tesi meccanicamente.
Seat springing with elastic straps in propylene fibre and mechanically stretched 80 mm lattice.
3. Struttura schiena relax in acciaio.
Relax back structure in steel.
4. Nastri elastici in fibra propilenica e lattice da 60 mm.
Elastic straps in propylene fibre and 60 mm lattice.
5. Imbottitura in poliuretano espanso indeformabile D28/40.
Padding in D28/40 non-deformable polyurethane foam.
6. Vellutino accoppiato a fibra di poliestere gr 300.
Velveteen bonded to 300 g polyester fibre.
7. Rivestimento completamente sfoderabile in tessuto, parzialmente sfoderabile in pelle o ecopelle.
Fully removable upholstery in fabric, partially removable in leather or faux leather.
8. Inserto in poliuretano espanso indeformabile D18 morbido.
Insert in D18 soft non-deformable polyurethane foam.
9. Cuscino schienale in mollapiuma canalizzata (piuma d'oca e fibra di poliestere).
Back cushion in mixed channelled filling (goose down and polyester fibre).
10. Rivestimento in ovatta di poliestere termolegata gr. 500.
Covering in 500 g thermo-bonded polyester wadding.
11. Cuscino seduta in poliuretano espanso indeformabile D32.
Seat cushion in D32 non-deformable polyurethane foam.
12. Bombatura seduta in poliestere espanso indeformabile D28 morbido.
Top of seat in D28 soft non-deformable polyester foam.
13. Piedino Nice di serie, Frame, Fine, Model optional.
Nice feet as standard, Frame, Fine, Model feet optional.
14. Bracciolo in poliuretano espanso indeformabile D30.
Armrest in D30 non-deformable polyurethane foam.

SAMOA SRL

31014 Colle Umberto (TV) - ITALY
Via I° Maggio, 9/11 (Z.I.)

Tel. +39 0438 388179
Fax +39 0438 430482

www.samoativani.com
www.bsideletti.it
info@samoativani.com

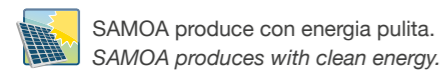

CREDITS:

Style
Centro stile Samoa, Treviso

Concept, Graphic design
Neiko, Treviso

Images
Neiko, Treviso

Print
Grafiche Antiga

