

sound
collection



sound collection

design in movimento



PLUS:
Sistema con movimento
orizzontale della schiena e
variazione profondità
della seduta

System with horizontal movement of
the back and adjustable seat depth

Collezione che si esprime attraverso il linguaggio del comfort e del dinamismo. Il design diventa funzionale grazie ad un meccanismo che consente di vivere momenti di relax o di conversazione a seconda del posizionamento della schiena e la conseguente variazione della profondità della seduta.

Collection that expresses itself through the language of comfort and dynamism.

Design becomes functional thanks to a mechanism which allows for experiencing moments of relaxation or conversation, depending on the positioning of the back and the consequent adjustment of the seat depth.

pag. 04 **harmòny**

pag. 44 informazioni tecniche



pag. 22 **mèlody**

pag. 46 informazioni tecniche

harmòny

Il design è minimal.

Un approccio contemporaneo che stravolge gli standard e racconta la vostra personalità.

The design is minimal.

A contemporary approach that alters the standards and defines your personality.





harmòny

Divano laterale cm 190 sx e penisola angolare con pouff e con schiena 45° cm 225 dx. Piede Jump finitura manganese. Cinque cuscini cm 55x30 e un cuscino cm 50x50.

190 cm left sided sofa and 225 cm right sided corner chaise with pouff and with 45° back. Jump feet in manganese finish. Five 55x30 cushions and one 50x50 cm cushion.

sound collection



harmòny

Divano laterale cm 190 sx e penisola angolare
con pouff e con schiena 45° cm 225 dx.
Piede Jump finitura manganese.
Un cuscino cm 55x30.

190 cm left sided sofa and 225 cm right sided
corner chaise with pouf and with 45° back.
Jump feet in manganese finish.
One 55x30 cm cushion.

Dettagli che
svelano un animo
raffinato dalla
forte connotazione
contemporanea.

Details that reveal a
refined essence with a
strong contemporary
connotation.



sound collection



harmòny

Divano cm 300.
Piede Jump finitura cromo.
Due braccioli Roll e due cuscini cm 55x30.

300 cm sofa.
Jump feet in chrome finish.
Two Roll armrests and
two 55x30 cm cushions.

sound collection





harmòny

Divano laterale cm 190 sx e
penisola angolare con pouff e
con Even colore beige dx.
Tre cuscini cm 55x30.

190 cm left sided sofa and right sided
corner chaise with pouf and Even in beige.
Three 55x30 cm cushions.

sound collection



harmòny

Divano laterale cm 190 sx e penisola angolare con pouff dx.
Due braccioli Tune.
Un cuscino cm 50x50, un cuscino cm 40x40 e un cuscino cm 55x30.

190 cm left sided sofa and right sided corner chaise with pouf. Two Tune armrests.
One 50x50 cm cushion, one 40x40 cm cushion and one 55x30 cm cushion.



harmòny

Elementi innovativi che diventano dettagli distintivi. Comodità e praticità trovano qui la giusta espressione.

Innovative elements that become distinctive details. Comfort and convenience discover the right form of expression.



sound collection



harmòny

Divano cm 240.
Piede Frame finitura manganese.
Un bracciolo Tune.
Un cuscino cm 55x30.

240 cm sofa.
Frame feet in manganese finish.
One Tune Armrest.
One 55x30 cm cushion.

sound collection



harmòny

Divano laterale cm 190 sx e panchetta dx.
Piede Frame finitura grigio.
Due braccioli Roll.
Due cuscini cm 55x30.

190 cm left sided sofa and right sided
bench. Frame feet in grey finish.
Two Roll armrests.
Two 55x30 cm cushions.

mélody

Il relax trova la sua forma
perfetta elevando il binomio
comfort e design.

Relaxation finds its perfect form of
expression by elevating the combination of
comfort and design.





mèlody

Divano cm 290.
Piede Frame finitura grigio.
Due cuscini cm 50x50,
un cuscino cm 40x40 e
due cuscini cm 55x30.

290 cm sofa.
Frame feet in grey finish.
Two 50x50 cushions, one 40x40 cm
cushion and two 55x30 cushions.

sound collection



mèlody

Divano laterale cm 185 sx e penisola angolare con pouff e con Even colore nero dx. Piede Jump finitura cromo. Un cuscino cm 50x50, un cuscino cm 40x40 e tre cuscini cm 55x30.

185 cm left sided sofa and right sided corner chaise with pouf and Even in black. Jump feet in chrome finish. One 50x50 cushion, one 40x40 cm cushion and three 55x30 cushions.



mèlody

Estrema cura nella definizione di ogni dettaglio. Risposte puntuali alle nuove esigenze estetiche.

Extreme care in the definition of every detail.
Timely solutions for the latest aesthetic requirements.



sound collection



mèlody

Divano laterale cm 185 sx e penisola angolare con pouff e con Even colore nero dx.
Piede Jump finitura cromo.
Tre cuscini cm 55x30.

185 cm left sided sofa and right sided corner chaise with pouf and Even in black.
Jump feet in chrome finish.
Three 55x30 cm cushions.

sound collection



mèlody

Divano cm 230.
Piede Frame finitura manganese.
Un cuscino cm 50x50 e
un cuscino cm 55x30.

230 cm sofa.
Frame feet in manganese finish.
One 50x50 cm cushion and
one 55x30 cm cushion.

sound collection



mèlody

**La leggerezza
strutturale e
compositiva conquista
lo spazio traducendosi
in comodità e cultura
del presente.**

The structural and compositional
lightness conquers the space,
translating into comfort and culture
characteristic of the present.



sound collection



mèlody

Centrale cm 80 e angolo
con bracciolo cm 235 dx.
Un cuscino cm 50x50, un cuscino
cm 40x40 e tre cuscini cm 55x30.

80 cm central section 235 cm right sided
corner section with armrest.
One 50x50 cushion, one 40x40 cm cushion
and three 55x30 cushions.



mèlody

Centrale cm 80 e angolo
con bracciolo cm 235 dx.
Un cuscino cm 40x40 e
un cuscino cm 55x30.

80 cm central section 235 cm right sided
corner section with armrest.
One 40x40 cm cushion and
one 55x30 cushion.



mèlody

Divano laterale cm 185 sx e panchetta dx.
Piede Jump finitura manganese.
Un cuscino cm 50x50,
un cuscino cm 40x40 e
un cuscino cm 55x30.

185 cm left sided sofa and right sided bench.
Jump feet in manganese finish.
One 50x50 cm cushion, one 40x40 cm
cushion and one 55x30 cm cushion.

Comode sedute e
poggiatesta regolabili
raccontano forma e
funzione. Tutto in
perfetto equilibrio.

Comfortable seating and
adjustable headrests
portray form and
function.
All in perfect balance.



sound collection



mèlody

Divano laterale cm 185 sx e panchetta dx.
Piede Jump finitura manganese.
Un cuscino cm 50x50, un cuscino cm 40x40,
un cuscino cm 55x30 e un cuscino poggiatesta.

185 cm left sided sofa and right sided bench.
Jump feet in manganese finish.
One 50x50 cm cushion, one 40x40 cm cushion,
one 55x30 cm cushion and
one headrest cushion.

sound collection

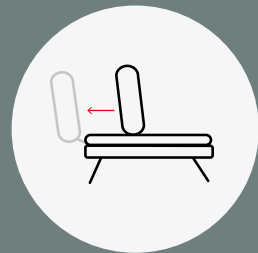

PLUS:
Sistema con movimento
orizzontale della schiena e
variazione profondità
della seduta
System with horizontal movement of
the back and adjustable seat depth

Informazioni Tecniche

Technical Sheet

harmòny

divani/elementi

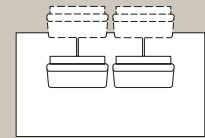
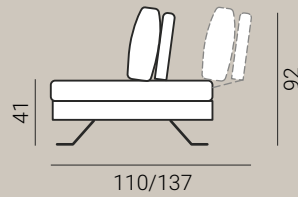

DIVANO
L 200 P 110/137 H 92

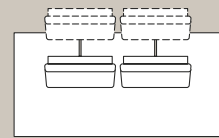

DIVANO
L 220 P 110/137 H 92

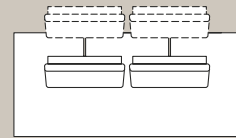

DIVANO
L 240 P 110/137 H 92

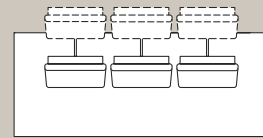

DIVANO
L 270 P 110/137 H 92

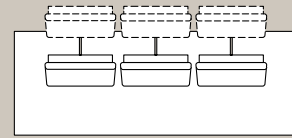

DIVANO
L 300 P 110/137 H 92

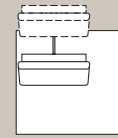

POLTRONA
LATERALE DX/SX
L 110 P 110/137 H 92

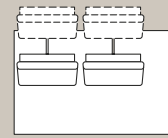

DIVANO
LATERALE DX/SX
L 170 P 110/137 H 92

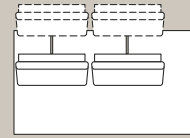

DIVANO
LATERALE DX/SX
L 190 P 110/137 H 92

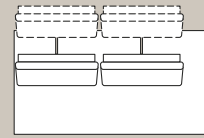

DIVANO
LATERALE DX/SX
L 210 P 110/137 H 92

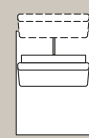

CENTRALE
L 80 P 110/137 H 92

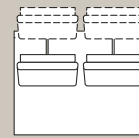

CENTRALE
L 140 P 110/137 H 92

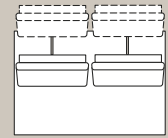

CENTRALE
L 160 P 110/137 H 92

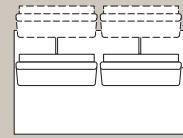

CENTRALE
L 180 P 110/137 H 92

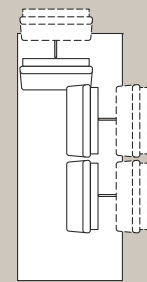

PENISOLA ANGOLARE
C/POUFF DX/SX
L 110/137 P 240/267 H 92

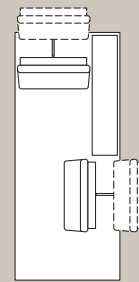

PENISOLA ANGOLARE
C/POUFF E C/EVEN DX/SX
L 110/137 P 240/267 H 92

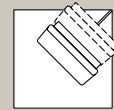

ANGOLO RETTO
C/ SCHIENA 45°
L 110 /120 P 110/120 H 92

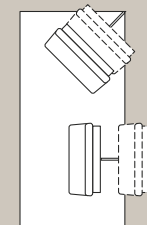

PENISOLA ANGOLARE
C/POUFF
C/SCHIENA 45° DX/SX
L 110/137 P 225/235 H 92

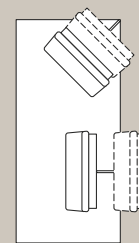

PENISOLA ANGOLARE
C/POUFF
C/SCHIENA 45° DX/SX
L 110/137 P 235/245 H 92

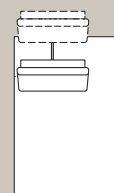

PANCHETTA DX/SX
L 110 P 165/192 H 92

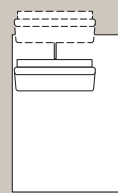

PANCHETTA MAXI
DX/SX
L 120 P 165/192 H 92



POUFF
L 110 P 110 H 41



POUFF
L 80 P 60 H 41



CUSCINO
L 40 X 40



CUSCINO
L 50 X 50



CUSCINO
L 55 X 30



CUSCINO POGGIATESTA
L 55 X 30

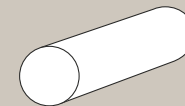

BRACCIOLO ROLL
Ø 22 P 92

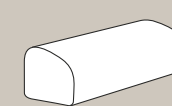

BRACCIOLO TUNE
L 28 P 92 H 18

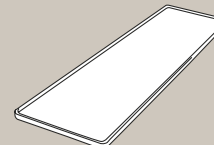

ACCESSORIO EVEN
L 34 x 125

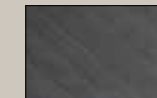

Finitura nera
di serie.

Standard black finishes.

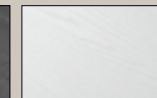

Finitura bianca
optional.

Optional white finishes.

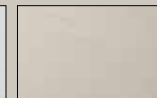

Finitura beige
optional.

Optional beige finishes.



Piede Zed finitura cromo
di serie.
Manganese **optional.**

*Zed feet in chrome finish as **standard.**
Optional manganese finish.*



Piede Jump finitura cromo o manganese
optional.

*Jump feet in chrome finish or in **optional**
manganese finish.*



Piede Frame finitura grigio o manganese
optional.

*Frame feet in grey finish or in **optional**
manganese finish.*

mèlody

divani/elementi

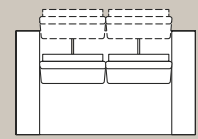
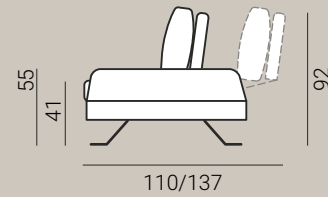

DIVANO
L 190 P 110/137 H 92

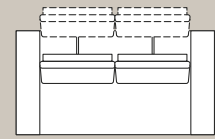

DIVANO
L 210 P 110/137 H 92

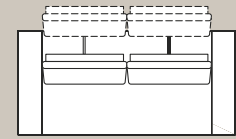

DIVANO
L 230 P 110/137 H 92

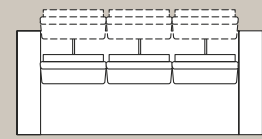

DIVANO
L 260 P 110/137 H 92

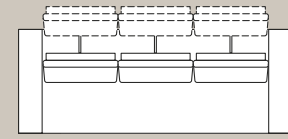

DIVANO
L 290 P 110/137 H 92

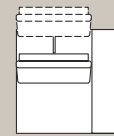

POLTRONA
LATERALE DX/SX
L 105 P 110/137 H 92

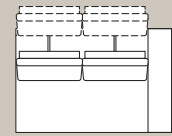

DIVANO
LATERALE DX/SX
L 165 P 110/137 H 92

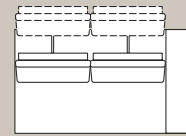

DIVANO
LATERALE DX/SX
L 185 P 110/137 H 92

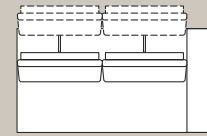

DIVANO
LATERALE DX/SX
L 205 P 110/137 H 92



CENTRALE
L 80 P 110/137 H 92

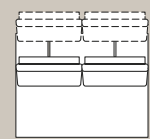

CENTRALE
L 140 P 110/137 H 92

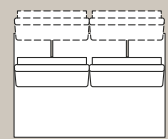

CENTRALE
L 160 P 110/137 H 92

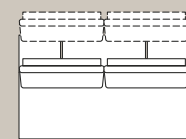

CENTRALE
L 180 P 110/137 H 92

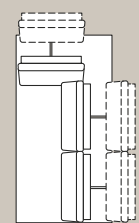

PENISOLA ANGOLARE
DX/SX
L 110/137 P 210/237 H 92

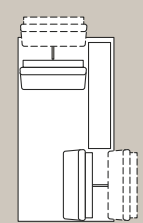

PENISOLA ANGOLARE
C/EVEN DX/SX
L 110/137 P 210/237 H 92

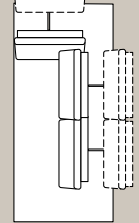

PENISOLA ANGOLARE
C/POUFF DX/SX
L 110/137 P 240/267 H 92

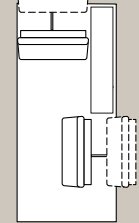

PENISOLA ANGOLARE
C/POUFF E C/EVEN DX/SX
L 110/137 P 240/267 H 92

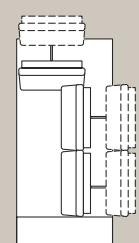

ANGOLO
C/BRACCIOLO DX/SX
L 110/137 P 235/262 H 92

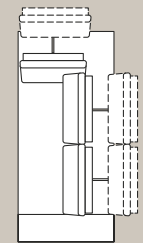

ANGOLO
C/BRACCIOLO DX/SX
L 110/137 P 245/272 H 92

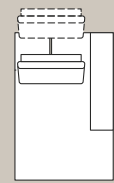

PANCHETTA DX/SX
L 105 P 165/192 H 92

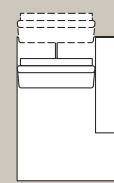

PANCHETTA MAXI
DX/SX
L 115 P 165/192 H 92



POUFF
L 110 P 110 H 41



POUFF
L 80 P 60 H 41



CUSCINO
L 40 X 40



CUSCINO
L 50 X 50



CUSCINO
L 55 X 30



CUSCINO POGGIATESTA
L 55 X 30

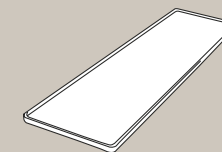

ACCESSORIO EVEN
L 34 x 125

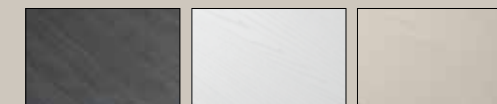

Finitura nera
di serie.

Standard black
finishes.

Finitura bianca
optional.

Optional white
finishes.

Finitura beige
optional.

Optional beige
finishes.



Piede Zed finitura cromo
di serie.
Manganese **optional.**

Zed feet in chrome finish
as **standard.**
Optional manganese
finish.



Piede Jump finitura
cromo o manganese
optional.

Jump feet in chrome
finish or in **optional**
manganese finish.



Piede Frame finitura
grigio o manganese
optional.

Frame feet in grey
finish or in **optional**
manganese finish.

harmòny / mèlody

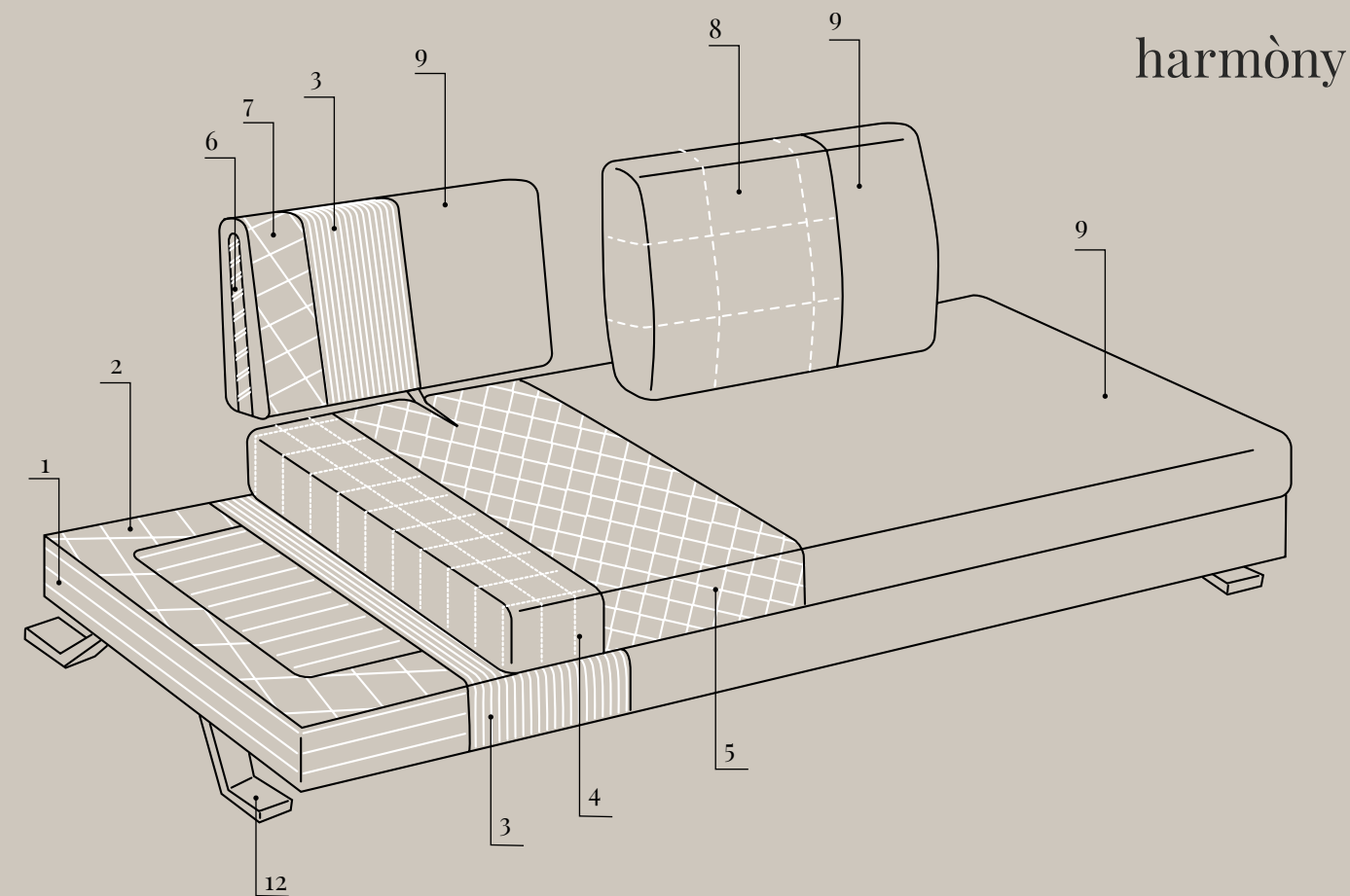

harmòny

Bracciolo
Harmòny
Roll

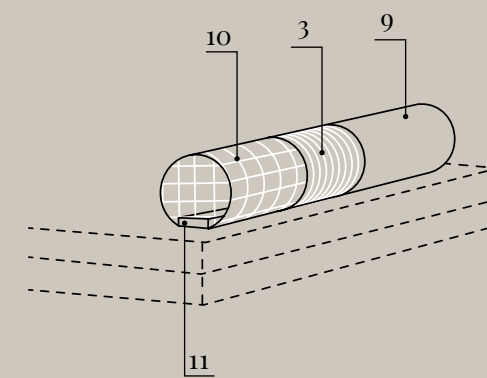

Bracciolo
Harmòny
Tune

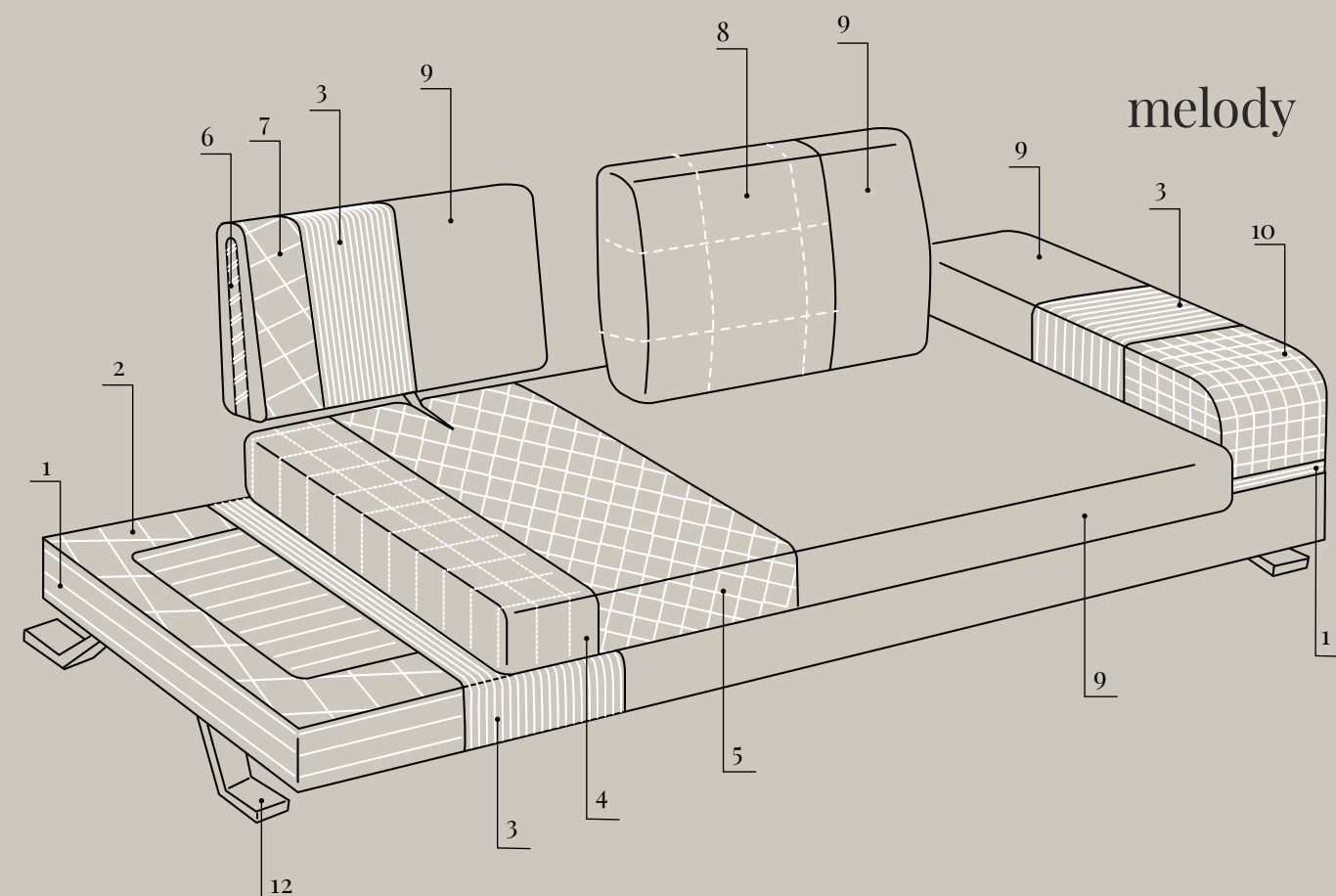
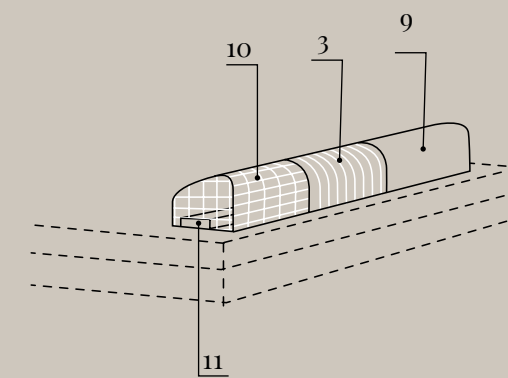

mèlody

Legenda

1. Struttura in legno stagionato e agglomerato
Structure in seasoned and bonded wood.
2. Imbottitura in poliuretano espanso indeformabile PK40.
Padding in PK40 non-deformable polyurethane foam.
3. Vellutino accoppiato a fibra di poliestere gr 300.
Velveteen bonded to 300 g polyester fibre.
4. Cuscino seduta in poliuretano espanso indeformabile D40 morbido.
Seat cushion in soft D40 non-deformable polyurethane foam.
5. Rivestimento in ovatta di poliestere gr 300.
Lining in 300 g polyester wadding.
6. Struttura e meccanismo per movimento orizzontale della schiena in acciaio.
Structure and mechanism for horizontal movement of the back in steel.
7. Imbottitura in poliuretano espanso indeformabile D30.
Padding in D30 non-deformable polyurethane foam.
8. Cuscino schienale in mollapiuma canalizzata (piuma d'oca e fibra di poliestere).
Back cushion in mixed channelled filling (goose down and polyester fibre).
9. Rivestimento completamente sfoderabile in tessuto, parzialmente sfoderabile in pelle o ecopelle.
Fully removable upholstery in fabric, partially removable in leather or faux leather.
10. Bracciolo in poliuretano espanso indeformabile D30.
Armrest in D30 non-deformable polyurethane foam.
11. Barra in metallo.
Metal bar.
12. Piede Zed di serie, Jump e Frame optional.
Zed feet as standard, Jump and Frame model feet optional.

harmòny



mèlody

Elementi innovativi che
diventano dettagli distintivi

SAMOA SRL

31014 Colle Umberto (TV) - ITALY
Via I° Maggio, 9/11 (Z.I.)

Tel. +39 0438 388179
Fax +39 0438 430482

www.samoativani.com
www.bsideletti.it
info@samoativani.com

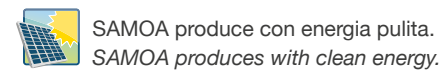

CREDITS:

Style
Centro stile Samoa, Treviso

Concept, Graphic design
Neiko, Treviso

Images
Neiko, Treviso

Print
Grafiche Antiga



SAMOA[®]
DIVANI E IMBOTTITI